

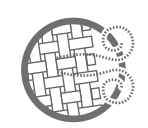

STABILITY IS A SNAP



Stealth's i-Fit line of pelvic belts, vests, chest straps and foot positioners are intended to be used as a way to increase trunk stability, aid in properly aligning the pelvis, and provide a more correct clinical posture in a wheelchair. With i-Fit, stability is a snap!



Breathable Material
Constructed from a unique open cell material, that allows air to circulate and moisture to escape. This contributes to reduced heat buildup and a cooler, drier, and more comfortable user experience.



Dynamic Support
Dynamic Support provides postural control, a degree of trunk movement, and a softer fit on the body. The user has movement within a limited range encouraging return to their neutral position.



Offset Belt Anchors
A slight offset allows for easy adjustment without loosening the anchor bolts.



Structured Support
i-Fit structured material is more resistant to high tone aiding in the maintenance of correct posture.



Swivel Buckles
Swivel buckles on the lower attaching straps allow self adjustment supporting the correct angle of attachment.



Full Length Attaching Straps
Provides for proper positioning of the side release buckles, ensuring that the posture support maintains adjustment.





Posture Support

- Breathable Material
- Dynamic & Structured Support
- Classic & Contoured Styles
- Swivel Buckles
- Full Range of Sizes
- Offset Belt Anchor
- Large Neck Cavity
- Full Length Attaching Straps

Classic Style

The Classic Style offers a large padded surface for the thoracic area.

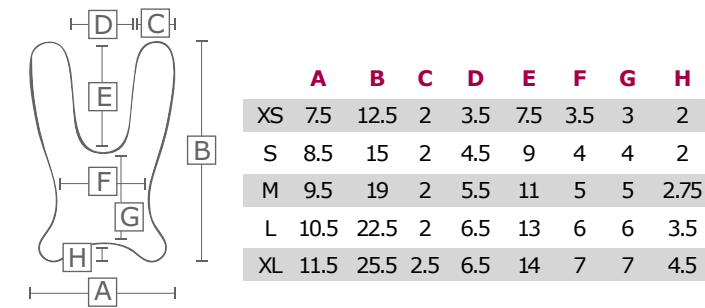

	XS	S	M	L	XL
Dynamic	IFPS1101	IFPS1102	IFPS1103	IFPS1104	IFPS1105
Structured	IFPS1201	IFPS1202	IFPS1203	IFPS1204	IFPS1205

Contoured Style

The Contoured Style has a narrowed section over the sternum that allows a better fit for females, G-tube users or those requiring a smaller support surface.

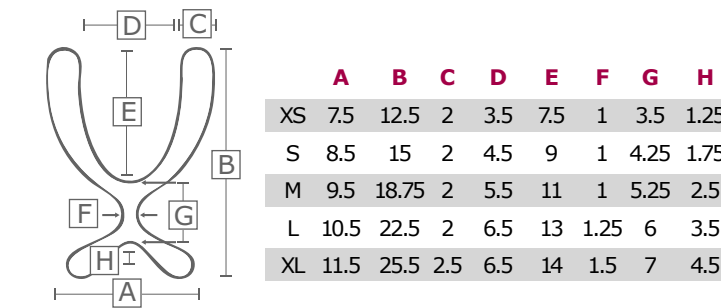

	XS	S	M	L	XL
Dynamic	IFPS2101	IFPS2102	IFPS2103	IFPS2104	IFPS2105
Structured	IFPS2201	IFPS2202	IFPS2203	IFPS2204	IFPS2205



CLASSIC STYLE VINYL FACE (DYNAMIC)

IFPS1401	Pull Down, Extra Small
IFPS1402	Pull Down, Small
IFPS1403	Pull Down, Medium
IFPS1404	Pull Down, Large
IFPS1405	Pull Down, Extra Large



CONTOURED STYLE VINYL FACE (DYNAMIC)

IFPS2401	Pull Down, Extra Small
IFPS2402	Pull Down, Small
IFPS2403	Pull Down, Medium
IFPS2404	Pull Down, Large
IFPS2405	Pull Down, Extra Large



CONTOURED STYLE ZIPPER FACE (DYNAMIC)

IFPS3101	Pull Down, Extra Small
IFPS3102	Pull Down, Small
IFPS3103	Pull Down, Medium
IFPS3104	Pull Down, Large
IFPS3105	Pull Down, Extra Large

CLASSIC STYLE VINYL FACE (STRUCTURED)

IFPS1301	Pull Down, Extra Small
IFPS1302	Pull Down, Small
IFPS1303	Pull Down, Medium
IFPS1304	Pull Down, Large
IFPS1305	Pull Down, Extra Large

CONTOURED STYLE VINYL FACE (STRUCTURED)

IFPS2301	Pull Down, Extra Small
IFPS2302	Pull Down, Small
IFPS2303	Pull Down, Medium
IFPS2304	Pull Down, Large
IFPS2305	Pull Down, Extra Large

CLASSIC STYLE ZIPPER FACE (STRUCTURED)

IFPS3201	Pull Down, Extra Small
IFPS3202	Pull Down, Small
IFPS3203	Pull Down, Medium
IFPS3204	Pull Down, Large
IFPS3205	Pull Down, Extra Large



BACKPACK STYLE STRAP, PAIR (STRUCTURED)

IFPB4201	Pull Down, Extra Small
IFPB4202	Pull Down, Small
IFPB4203	Pull Down, Medium
IFPB4204	Pull Down, Large



H-STYLE HARNESS (STRUCTURED)

IFHH5201	Pull Down, Extra Small
IFHH5202	Pull Down, Small
IFHH5203	Pull Down, Medium
IFHH5204	Pull Down, Large

Chest Straps (All chest straps are dynamic)



	A	B	C
Belt Anchor XS	14	2.8	3.5
Belt Anchor S	16	2.8	3.75
Belt Anchor M	18	3.1	4
Belt Anchor L	21	3.1	4.5
Belt Anchor XL	23	3.25	4.75

	A	B
Velcro XS	7	2
Velcro S	8.5	3
Velcro M	10.25	4
Velcro L	11.5	5
Velcro XL	13	6

	XS	S	M	L	XL
Belt Anchor	IFCS4111	IFCS4112	IFCS4113	IFCS4114	IFCS4115
Velcro	IFCS4121	IFCS4122	IFCS4123	IFCS4124	IFCS4125

Y Straps

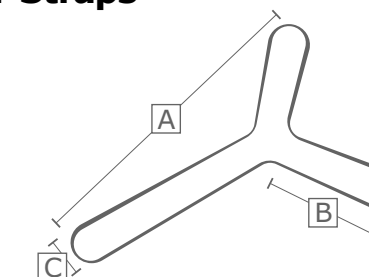

	A	B	C
S	19	8	2
M	22	9	2.25
L	25	11	2.5

	S	M	L
Dynamic	IFYS3102	IFYS3103	IFYS3104
Structured	IFYS3202	IFYS3203	IFYS3204

All Sizes Are Inches



Pelvic Belts & Pads

- Two & Four Point Supports
- Padded & Non-Padded (XS to XL)
- 1 inch, 1-1/2 inch, & 2 inch
- Single & Dual Pull
- Metal Push Button or Side Release
- Various Attachment Styles

Part Numbers



2 POINT NON-PADDED BELTS (PUSH BUTTON)

- IFPB5110 Push Button, 1 in, Single Pull, Non-Padded
- IFPB5210 Push Button, 1.5 in, Single Pull, Non-Padded
- IFPB5310 Push Button, 2 in, Single Pull, Non-Padded
- IFPB5350 Pelvic Belt, Push Button, 2 in, Retractable, Non-Padded

2 POINT NON-PADDED (SIDE RELEASE)

- IFPB6110 Side Release, 1 in, Single Pull, Non-Padded (shown above)
- IFPB6210 Side Release, 1.5 in, Single Pull, Non-Padded



2 Point Pad Sizes

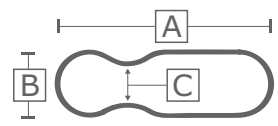

	Part Number	A	B	C
XS	IFPB101	4.25	1.75	1.25
S	IFPB102	5.5	1.75	1.25
M	IFPB103	7.5	2.5	1.75
L	IFPB104	9.5	2.75	2.25
XL	IFPB105	11.5	2.75	2.25

4 Point Pad Sizes

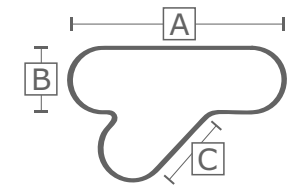

	Part Number	A	B	C
XS		4.25	1.75	3.25
S		5.5	2.25	4
M		7.5	2.5	4
L		9.5	2.25	4

Belt Sizes

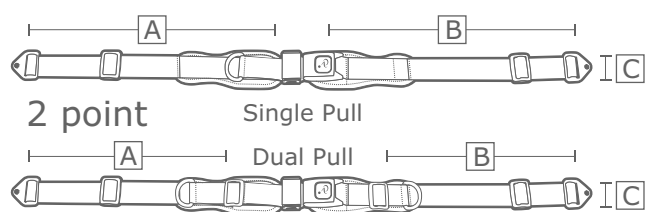

	A	B	C	Buckle	Pad Sizes
Single Pull	32	27	1	PB	NP / XS
Single Pull	32	27	1	SR	NP
Dual Pull	24	24	1	PB	XS / S
Single Pull	32	27	1.5	PB / SR	NP / M / L
Dual Pull	24	24	1.5	PB / SR	M / L
Single Pull	32	27	2	PB	NP / L / XL
Single Pull	32	27	2	SR	L / XL
Dual Pull	24	24	2	PB / SR	L / XL

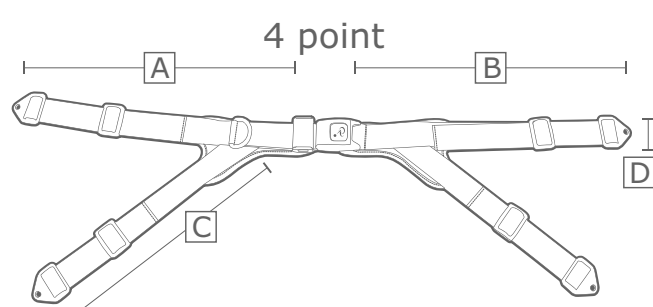

	A	B	C	D	Buckle	Sizes
4 point	32	27	20	1	PB	XS
	32	27	20	1.5	PB	S / M / L



2 POINT PADDED BELTS (DUAL PULL)

- IFPB5121 Push Button, 1 in, Dual Pull, Extra Small Pads (4.5 in)
- IFPB5122 Push Button, 1 in, Dual Pull, Small Pads (5.5 in)

1 1/2 inch belts

- IFPB5223 Push Button, 1.5 in, Dual Pull, Medium Pads (7.5 in)
- IFPB6223 Side Release, 1.5 in, Dual Pull, Medium Pads (7.5 in)
- IFPB5224 Push Button, 1.5 in, Dual Pull, Large Pads (9.5 in)
- IFPB6224 Side Release, 1.5 in, Dual Pull, Large Pads (9.5 in)

2 inch belts

- IFPB5324 Push Button, 2 in, Dual Pull, Large Pads (9.5 in)
- IFPB6324 Side Release, 2 in, Dual Pull, Large Pads (9.5 in)
- IFPB5325 Push Button, 2 in, Dual Pull, Extra Large Pads (11.5 in)
- IFPB6325 Side Release, 2 in, Dual Pull, Extra Large Pads (11.5 in)



4 POINT BELTS (V-CONTOUR STYLE)

- IFPB5141 Push Button, 1 in, 4-Point, Extra Small Pads (4.5 in)

1 1/2 inch belts

- IFPB5242 Push Button, 1.5 in, 4-Point, Small Pads (5.5 in)
- IFPB5243 Push Button, 1.5 in, 4-Point, Medium Pads (7.5 in)
- IFPB5244 Push Button, 1.5 in, 4-Point, Large Pads (9.5 in)



4 POINT BELTS (LINEAR STYLE)

- IFPB5145 Push Button, 1 in, 4-Point, Extra Small Pads (4.5 in)

1 1/2 inch belts

- IFPB5146 Push Button, 1.5 in, 4-Point, Small Pads (5.5 in)
- IFPB5147 Push Button, 1.5 in, 4-Point, Medium Pads (7.5 in)
- IFPB5148 Push Button, 1.5 in, 4-Point, Large Pads (9.5 in)



2 POINT PADDED BELTS (SINGLE PULL)

- IFPB5111 Push Button, 1 in, Single Pull, Extra Small Pads (4.5 in)
- IFPB5112 Push Button, 1 in, Single Pull, Small Pads (5.5 in)

1 1/2 inch belts

- IFPB5213 Push Button, 1.5 in, Single Pull, Medium Pads (7.5 in) (shown above)
- IFPB6213 Side Release, 1.5 in, Single Pull, Medium Pads (7.5 in)
- IFPB5214 Push Button, 1.5 in, Single Pull, Large Pads (9.5 in)
- IFPB6214 Side Release, 1.5 in, Single Pull, Large Pads (9.5 in)

2 inch belts

- IFPB5314 Push Button, 2 in, Single Pull, Large Pads (9.5 in)
- IFPB6314 Side Release, 2 in, Single Pull, Large Pads (9.5 in)
- IFPB5315 Push Button, 2 in, Single Pull, Extra Large Pads (11.5 in)
- IFPB6315 Side Release, 2 in, Single Pull, Extra Large Pads (11.5 in)



RETRACTABLE SEATBELT

- IFRB5350 Modification, Pevic Belt, Push Button, Retractable 2" web, Non Padded

Foot Positioning

Ankle Support Sizes

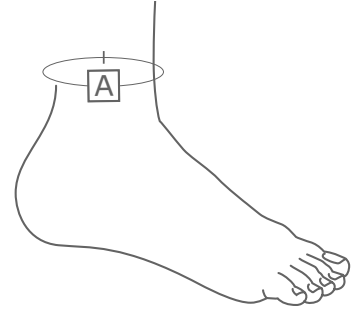

	A (Circumference)
XS	6-8
S	7-8.5
M	8-11
L	9-12
XL	12.5-15

Shoe Holder Sizes

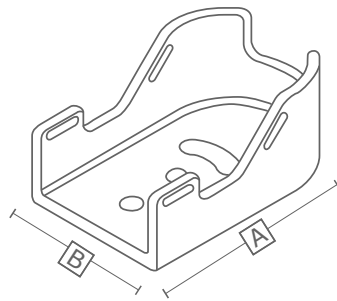

	A	B
S	5	3
M	6.25	3.5
L	7.75	4.25

Components

IFFP0110	Dynamic Ankle Support REPLACEMENT , XS
IFFP0111	Dynamic Ankle Support REPLACEMENT , S
IFFP0122	Dynamic Ankle Support REPLACEMENT , M
IFFP0123	Dynamic Ankle Support REPLACEMENT , L
IFFP0124	Dynamic Ankle Support REPLACEMENT , XL
IFTS2111	Padded Toe Strap, Foot Positioning System, S
IFTS2122	Padded Toe Strap, Foot Positioning System, M
IFTS2123	Padded Toe Strap, Foot Positioning System, L
IFFP100-01	Foot & Ankle Base Plate REPLACEMENT , S
IFFP100-02	Foot & Ankle Base Plate REPLACEMENT , M
IFFP100-02	Foot & Ankle Base Plate REPLACEMENT , L

Padded Toe Strap



ANKLE POSITIONING SYSTEMS

IFFP1110	Dynamic 3/4 in Webbing, Extra Small
IFFP1111	Dynamic 3/4 in Webbing, Small
IFFP1122	Dynamic 1 in Webbing, Medium
IFFP1123	Dynamic in Webbing, Large
IFFP1124	Dynamic 1 in Webbing, Extra Large



FULL FOOT POSITIONING

IFFP2110	Dynamic 3/4 in Webbing, Extra Small
IFFP2111	Dynamic 3/4 in Webbing, Small
IFFP2122	Dynamic 1 in Webbing, Medium
IFFP2123	Dynamic 1 in Webbing, Large
IFFP2124	Dynamic 1 in Webbing, Extra Large



FIXED ANKLE SUPPORTS

IFFP3210	Structured 3/4 in Webbing, Extra Small
IFFP3211	Structured 3/4 in Webbing, Small
IFFP3212	Structured 1 in Webbing, Medium
IFFP3213	Structured 1 in Webbing, Large
IFFP3214	Structured 1 in Webbing, Extra Large



SHOE HOLDERS

IFSH4211	Shoe Holder, Padded straps 3/4 in Webbing, S
IFSH4212	Shoe Holder, Padded straps 3/4 in Webbing, M
IFSH4213	Shoe Holder, Padded straps 3/4 in Webbing, L
IFTS4211	Padded Toe Strap Only, S
IFTS4212	Padded Toe Strap Only, M
IFTS4213	Padded Toe Strap Only, L
IFSH4001	Shoe Holder Pad, Velcro, S
IFSH4002	Shoe Holder Pad, Velcro, M
IFSH4003	Shoe Holder Pad, Velcro, L

Buckle Cover



Accessories

IFMDBC10	Modification, Buckle Cover Kit. 1 in Buckle
IFMDBC15	Modification, Buckle Cover Kit. 1.5 in Buckle
IFMDCM	Modification, Cam Buckle Mount Kit.
IFMDCC	Modification, Cane Clamp Kit.

Cane Clamp





Distributed by

Pride Mobility Products Canada • 5096 South Service Road • Beamsville, Ontario L0R 1B3

PH: 888-570-1113 • FAX: 866-514-1303 • www.pridemobility.com

stealthproducts.com